

MAXIMATOR®

HIGH PRESSURE
TECHNOLOGY
HYDRAULICS
PNEUMATICS
TESTING
EQUIPMENT



MAXIMATOR GmbH

Packaged Pump Systems

Description and function of MAXIMATOR power packs

MAXIMATOR power packs for oil, water or aggressive media are complete hydraulic units ready for connection which are provided for generating operating pressures up to 5,500 bar. The hydraulic systems can be used for all kinds of testing and clamping or for other functions requiring a determined pressure.

The pressure will be generated by means of a pneumatically operated MAXIMATOR pump. The pump will be connected to the existing industrial compressed-air ductwork system. For generating the pressure, an electric connection will not be necessary.

MAXIMATOR power packs can be equipped with all MAXIMATOR pumps. Restrictions result only from determined structural dimensions as well as from the flow rates of the pumps being necessary for the respective function.

For the simple commissioning and unproblematic application, MAXIMATOR power packs will be equipped with all required components. Part of them is an air control unit with combined filter and water separator, a pressure-regulating valve, a pressure control gauge as well as a manual shut-off valve for stopping off the drive air pressure.

For all applications within the range of the oil hydraulic, the pumps will be mounted in the oil tank in a compact and space saving manner. In case of operation with water or with aggressive media, the pump will be mounted on the tank. According to standard, there can be selected among tank capacities from 6.5 l to 70 l. Larger-sized tanks are available on demand.

On request, the tanks can be provided with carrying handles or on wheels (to be recommended for all G-type pumps as well as for tank capacities from 30 l).



On the high-pressure side, the power pack will be equipped with a pressure relief valve (expansion valve) as well as with a manifold block with one or several pressure outlets for connecting the test pieces (which can be shut off separately or completely on request).

For indicating and monitoring the operating pressure, liquid-damped pressure gauges of the accuracy class 1.0 or 1.6 (higher accuracies are possible on demand) can be delivered in different sizes for pressures up to 7,000 bar.

With the above specified scope of supply, the MAXIMATOR power pack is ready for connection. For operating the hydraulic unit, only the drive air piping has to be connected and the tank has to be filled with the provided operating liquid.

MAXIMATOR offers an extensive volume of accessories for all cases of application. Part of them are pressure switches, float valves and pneumatically or electrically operated directional valves for actuating cylinders. Connecting adaptors, quick couplings, pressure filters, high-pressure hoses as well as shut-off valves and control valves are available too.

We design the MAXIMATOR power packs according to your requirements. Our sales engineers in the engineering departments as well as our co-workers in the Works Zorge are pleased to give you expert advice and will recommend you the respective power pack being suitable for your special case of application.

Applications for MAXIMATOR power packs

The movable and portable MAXIMATOR hydraulic power packs can be used wherever hydraulic pressures are required. They are to be found for example in the steel construction, boiler construction, tank construction and reactor construction as well as in yards, smelting plants, machine factories and locksmith's shops. For years they have proved themselves in inspection and acceptance processes as well as in the hydraulic working and clamping systems.

The power packs are also provided for actuating hydraulic punches and punch systems. Among others they will be used in aircraft yards for lifting aircrafts, for clamping large-sized devices, for checking pressure vessels and pressure systems.

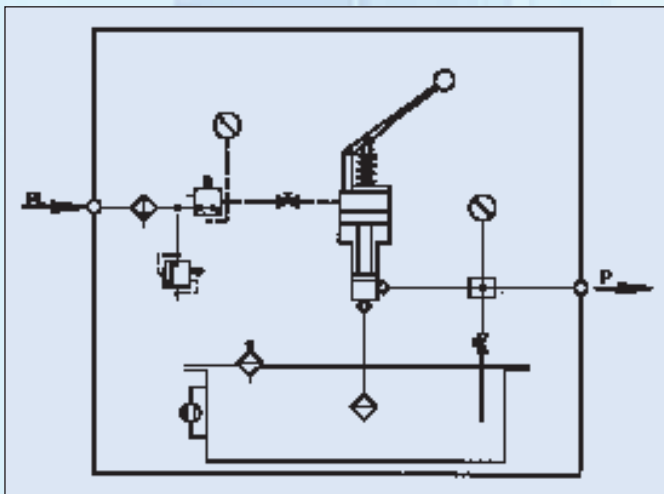

In the tool hydraulic, MAXIMATOR units will be used for pressure oil junctions as well for mounting and pulling-off large-sized toothed gears.

Furthermore, the systems will be used in hydraulic presses, among others also when high pressure must be maintained for a long time, such as in case of tire and vulcanizing presses as well as for presses overload protections. For such purposes, the hydraulic unit can be delivered with reversing devices permitting an one-sided or also two-sided admission to the press. Direct admission of compressed air to the return side enables a connection for

the quick return. The hydraulic units have also proved to be an outstanding solution for isostatic pressing procedures.

For realizing regular pressure tests (TÜV) at pressure vessels, MAXIMATOR offers the complete solution with regard to the pressure generation. These power packs will always be set up upon customer's request.

The required hydraulic pressure will be generated by means of air-lift pump. In this connection, the hydraulic pressure corresponds to the set air pressure multiplied by the transmission ratio of the pump. When the appliance reaches the pre-set pressure, it stops automatically and maintains the pressure until arising a pressure drop caused through leakage or the like. The appliance starts automatically and functions again until having reached the pre-set pressure.

All the controlling and regulating processes are of unsurpassed simplicity because of the compressed-air drive. So, the complete appliance is very robust, operationally reliable and insensitive to hardest operating stresses. The power pack will not be damaged through moist rooms, dust or higher temperatures. The MAXIMATOR hydraulic units are explosion-proof because no electric energy is required.

Advantages of the MAXIMATOR power packs

- Standstill of the pump when reaching the set final pressure
- No energy consumption in case of long pressure holding times
- No dissipated heat during the pressure holding phase
- Substitute of leakages by automatic re-delivery through the pump
- Control of the operating pressure through simple adjustment of the aire drive pressure
- Simple installation, operationally reliable, easy to maintain

MAXIMATOR® Packaged Pump Systems for Outlet Pressures up to 5,500 bar

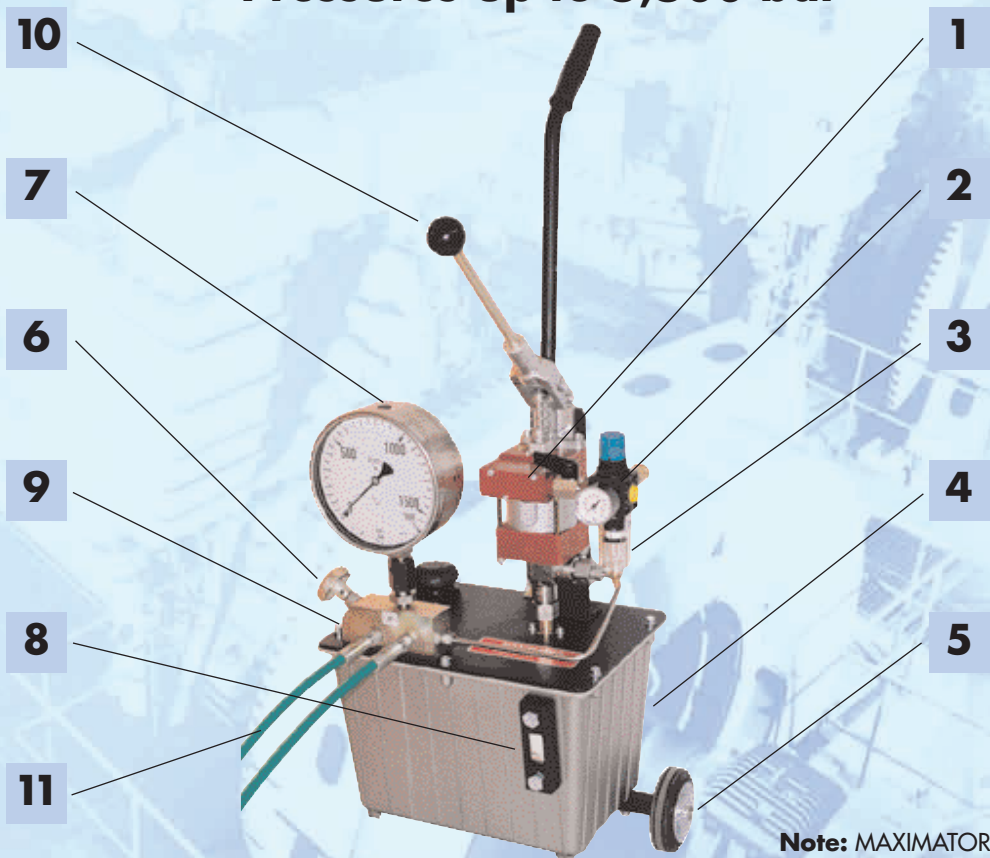

Note: MAXIMATOR pumps MO and S series are integrated in the tank. All other pump series will be mounted on top of the tank.

Components in Modular Design:

- | | |
|--|---|
| <p>1 Pump model
MO, S for oil service up to maximum 1,000 bar; M, G for oil and water service up to maximum 5,500 bar; MSF, GSF for special liquids to maximum 1,450 bar</p> <p>2 Air control unit, comprising combined filter pressure regulator, control pressure gauge and shut-off valve
C1 for M series
C1.5 for S series
C2 for G series</p> <p>3 Air safety valve
SV mounted in the air line</p> <p>4 Tank sizes
6.5 liter
13 liter
30 liter
70 liter
Standard of aluminium, stainless steel on request</p> <p>5 Mobility of the packaged pump system
F moveable
T portable
K jack ring</p> <p>6 Relief valve
EV with return line to the tank</p> | <p>7 Pressure gauge
Pressure range / Diameter of the housing (cl. 1.6/1.0/0.6, glycerine damped)</p> <p>8 Operating liquid
O Oil (tank of aluminium, components galvanized)
W Water (tank of aluminium, components of SS)
VA Stainless steel (tank of 1.4571 or 1.4305)</p> <p>9 Manifold block with pressure outlet(s)
A1 1 pressure outlet to
A6 6 pressure outlets, depending on tank size
V Option: Shut-off valve for pressure outlet (AV1-AV6)</p> <p>10 Hand lever
H only available for M22 to M189, single acting, single stage</p> <p>11 Other options:
SCHW Float valve for automatic filling of the tank, i. e. from the water line
SCHL HP hose, model SK
ZR Additional return connection</p> <p>Specials on request</p> |
|--|---|

1 2 3 4 5 6 7 8 9 10 11

Coding example: M 189-01 / C1 / SV / 13 / F / EV / 0-1600 (160) / W / A2 / H / SCHL

Power pack with pump type M189-01 with hand lever, air control unit "C1", air safety valve, aluminium tank, volume 13 liter, on wheels, manually relief valve EV, pressure gauge 0-1,600 bar, Ø 160 mm, suitable for water service, manifold block with two pressure outlets, 2 pcs. hoses

MAXIMATOR large pump G series

Single acting, single air drive head					
Type	Pressure ratio **	Displacement volume cm ³ *	Outlet pressure max. ***	Flow l/min ****	
G 10L	1 : 11	90.0	110	18.53	
G 15L	1 : 16	62.0	160	12.86	
G 25L	1 : 28	35.3	280	7.24	
G 35L	1 : 40	24.5	400	5.02	
G 60L	1 : 63	15.4	630	3.21	
G 100L	1 : 113	8.8	1050	1.81	
G 150L	1 : 151	6.6	1450	1.36	
G 250L	1 : 265	3.8	2650	0.77	
G 300L	1 : 314	3.2	3140	0.65	
G 400L	1 : 398	2.5	3900	0.51	
G 500L	1 : 591	1.9	4500	0.39	
GX 35	1 : 36	180	360	24.50	
GX 60	1 : 66	65	600	23.00	
GX 100	1 : 117	36	1000	9.00	

Single acting, double or triple air drive head					
Type	Pressure ratio **	Displacement volume cm ³ *	Outlet pressure max. ***	Flow l/min ****	
G 10-2L	1 : 22	90.0	220	15.89	
G 15-2L	1 : 32	62.0	320	11.02	
G 25-2L	1 : 56	35.3	560	6.19	
G 35-2L	1 : 80	24.5	800	4.30	
G 60-2L	1 : 126	15.4	1260	2.70	
G100-2L	1 : 226	8.8	2100	1.55	
G150-2L	1 : 300	6.6	2900	1.16	
G250-2L	1 : 530	3.8	4500	0.66	
G300-2L	1 : 628	3.2	4500	0.56	
G400-2L	1 : 796	2.5	5500	0.44	
G500-2L	1 : 1038	1.4	5500	0.23	

Double acting, single air drive head					
Type	Pressure ratio **	Displacement volume cm ³ *	Outlet pressure max. ***	Flow l/min ****	
G 10D	1 : 10	180.0	100	28.85	
G 15D	1 : 15	124.0	150	19.84	
G 25D	1 : 27	70.6	270	11.34	
G 35D	1 : 40	29.0	400	7.74	
G 60D	1 : 63	31.4	630	5.04	
G 100D	1 : 113	17.6	1050	2.78	
G 150D	1 : 151	7.6	1450	2.10	

Single acting, single air drive head for special liquids					
Type	Pressure ratio **	Displacement volume cm ³ *	Outlet pressure max. ***	Flow l/min ****	
GSF 10L	1 : 11	90.0	110	18.53	
GSF 15L	1 : 16	62.0	160	12.86	
GSF 25L	1 : 28	35.3	280	7.24	
GSF 35L	1 : 40	24.5	400	5.02	
GSF 60L	1 : 63	15.7	630	3.21	
GSF 100L	1 : 113	8.8	1050	1.81	
GSF 150L	1 : 151	6.6	1450	1.36	

MAXIMATOR standard pump S series

Type	Pressure ratio **	Displacement volume cm ³ *	Outlet pressure max. ***	Flow l/min ****	
S 15	1 : 17	28.3	170	9.38	
S 25	1 : 25	19.6	250	6.72	
S 35	1 : 39	12.6	390	4.31	
S 60	1 : 61	8.0	610	2.75	
S 100	1 : 108	4.5	1000	1.55	
S 150	1 : 156	3.1	1000	1.08	
S 350	1 : 370	1.3	3000	0.40	

Type	Pressure ratio **	Displacement volume cm ³ *	Outlet pressure max. ***	Flow l/min ****	
S 15D	1 : 16	57.0	160	17.56	
S 25D	1 : 24	39.0	240	12.00	
S 35D	1 : 30	25.0	300	7.58	
S 60D	1 : 60	16.0	600	4.80	
S 100D	1 : 107	9.0	1000	2.68	
S 150D	1 : 155	6.2	1000	1.85	

MAXIMATOR mini pump M series

Type	Pressure ratio **	Displacement volume cm ³ *	Outlet pressure max. ***	Flow l/min ****	
M 4L	1 : 4	30.5	40	14.81	
M 8L	1 : 9	14.7	90	7.07	
M 12L	1 : 14	9.4	140	4.55	
M 22L	1 : 28	4.6	280	2.22	
M 37L	1 : 46	2.8	460	1.36	
M 72L	1 : 86	1.5	860	0.72	
M 111L	1 : 130	1.0	1300	0.48	
M 189L	1 : 220	0.6	2200	0.28	

Type	Pressure ratio **	Displacement volume cm ³ *	Outlet pressure max. ***	Flow l/min ****	
M111-2L	1 : 266	1.0	2500	0.35	
M189-2L	1 : 450	0.6	4000	0.21	
M111-3L	1 : 399	1.0	2500	0.24	
M189-3L	1 : 675	0.6	4000	0.14	

Type	Pressure ratio **	Displacement volume cm ³ *	Outlet pressure max. ***	Flow l/min ****	
M 22D	1 : 28	9.2	280	3.91	
M 37D	1 : 46	5.6	460	2.35	
M 72D	1 : 86	3.0	860	1.24	
M 111D	1 : 130	2.0	1300	0.82	
M 189D	1 : 220	1.2	2200	0.49	

Type	Pressure ratio **	Displacement volume cm ³ *	Outlet pressure max. ***	Flow l/min ****	
MSF 4L	1 : 4	30.5	40	14.81	
MSF 8L	1 : 9	14.7	90	7.07	
MSF 12L	1 : 14	9.4	140	4.55	
MSF 22L	1 : 28	4.6	280	2.22	
MSF 37L	1 : 46	2.8	460	1.36	
MSF 72L	1 : 86	1.5	860	0.48	
MSF111L	1 : 130	1.0	1000	0.28	

MAXIMATOR mini pump MO series

Type	Pressure ratio **	Displacement volume cm ³ *	Outlet pressure max. ***	Flow l/min ****	
MO 4	1 : 4	30.5	40	14.80	
MO 8	1 : 9	14.7	90	7.07	
MO 12	1 : 14	9.4	140	4.55	
MO 22	1 : 29	4.6	290	2.22	
MO 37	1 : 47	2.8	470	1.36	
MO 72	1 : 88	1.5	880	0.72	
MO 111	1 : 133	1.0	1000	0.48	
MO 189	1 : 225	0.6	1000	0.28	

Type	Pressure ratio **	Displacement volume cm ³ *	Outlet pressure max. ***	Flow l/min ****	
MO 22D	1 : 28	9.2	280	3.91	
MO 37D	1 : 46	5.6	460	2.35	
MO 72D	1 : 86	3.0	860	1.24	
MO111D	1 : 130	2.0	1000	0.82	
MO189D	1 : 220	1.2	1000	0.49	

* Displacement volume / Double stroke – calculated
 ** Pressure ratio – Area lp-piston/hp-piston - calculated
 *** Static Outlet pressure at an air drive of 10 bar – calculated
 resp. maximum permitted outlet pressure / Conversion bar : psi = 1 : 14.5
 **** Approx. Flow at an air drive of 6 bar and an outlet of 0 bar

MAXIMATOR® Hydraulic Unit**Type S 60****Configuration**

The power pack contains the following components:

- MAXIMATOR pump S60
- Aluminium tank of 6.5 liter
- Manifold block with pressure outlet
- Pressure gauge 0 – 600 bar, Ø 63 mm
- Air control unit
- Pneumatically operated relief valve

**Advantages**

- Small dimensions
- Low weight
- Easy to handle
- No energy consumption after having reached the set final pressure
- Compressed air drive, no explosion hazard

Application

This power pack will be used wherever is to be built up a hydraulic pressure locally. It is provided for all functions within the tool and clamping hydraulic, e.g. for

- pressure tests
- pulling-off devices
- shop presses
- and many more

Technical features

Pump model:	S 60
Pressure ratio:	1 : 61
Maximum outlet pressure:	610 bar
Maximum air drive pressure:	10 bar
Maximum flow capacity:	approx. 2.7 l/min
Approx. dimensions of the power pack (LxWxH):	260 x 220 x 350 mm
Approx. weight of the power pack:	11 kg

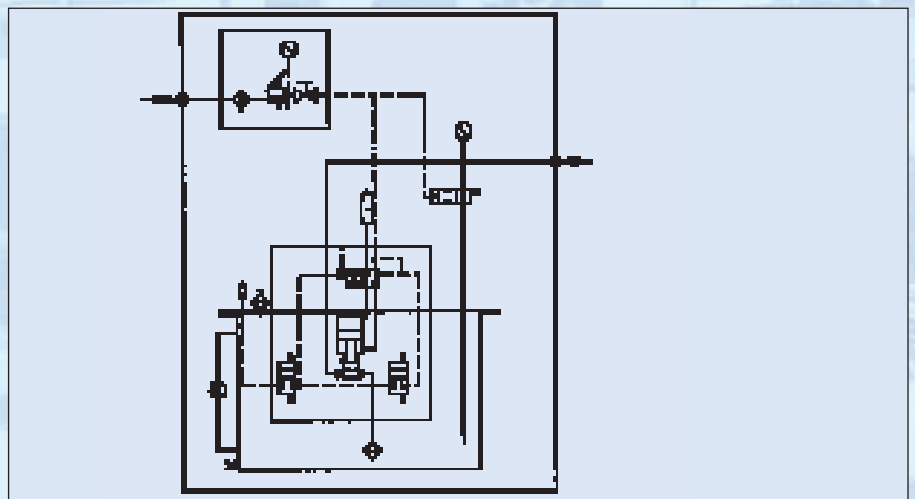

MAXIMATOR® Hydraulic Unit**Type MO 72 D****Configuration**

The power pack contains the following components:

- MAXIMATOR pump MO72D
- Aluminium tank of 6.5 liter
- Manifold block with pressure outlet
- Pressure gauge 0-600 bar, Ø 63 mm
- Air control unit
- Safety valve in the air line
- Pneumatically operated relief valve

**Advantages**

- No damage of the sheet surface
- Optimized feed - high cycle time
- No energy consumption after having reached the set final pressure
- No heating of the pressure medium

Application

The power pack presented here will be used in the feed units at eccentric presses. It keeps the hydraulic pressure in the cylinders for the pressure drum constant. So will be reached a continuous contact pressure which permits an optimized feed of the sheet to be stamped.

Technical features

Pump model:	MO 72 D
Pressure ratio:	1 : 86
Maximum outlet pressure:	860 bar
Maximum air drive pressure:	7 bar
Maximum flow capacity:	approx. 1.2 l/min
Approx. dimensions of the power pack (LxWxH):	260 x 240 x 250 mm
Approx. weight of the power pack:	9.5 kg

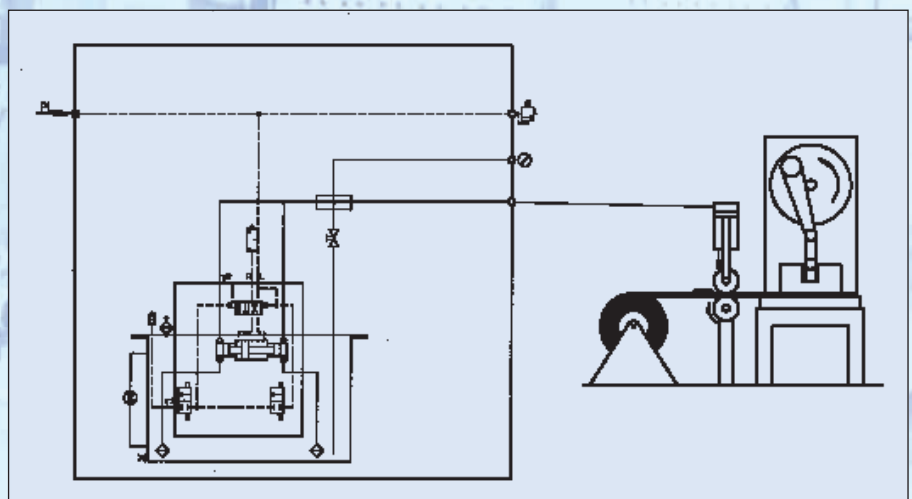

MAXIMATOR® Hydraulic Unit

Type M0 72

Configuration

The power pack contains the following components:

- MAXIMATOR pump MO72
- Aluminium tank of 6.5 liter
- Valve block
- 5 pcs. electrically operated directional valves
- Pressure release valve
- High pressure filter

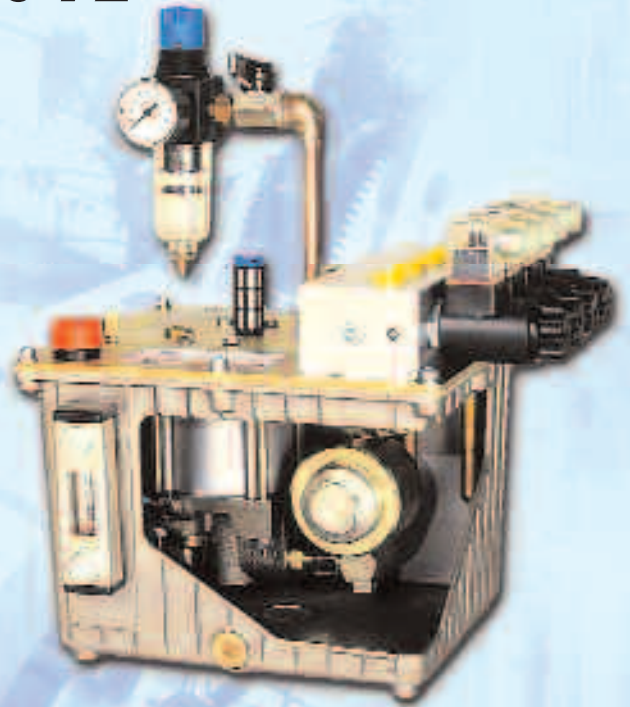

Advantages

- Constant pressing of the feed rolls
- Exact dosage of the sealing material
- No energy consumption after having reached the set final pressure
- No heating of the pressure medium

Application

This MAXIMATOR hydraulic unit will be used in a line for manufacturing insulating glass. The mounted directional valves are actuating hydraulic cylinders which will be pressed on every side against the insulating glass pane by means of a feed roll. Furthermore, the power pack actuates a hydraulic cylinder applying the sealing material in exact dosages to the glass panes.

Technical features

Pump model:	MO 72
Pressure ratio:	1 : 86
Maximum outlet pressure:	860 bar
Maximum air drive pressure:	10 bar
Maximum flow capacity:	approx. 0.7 l/min
Approx. dimensions of the power pack (LxWxH):	315 x 220 x 270 mm
Approx. weight of the power pack:	12 kg

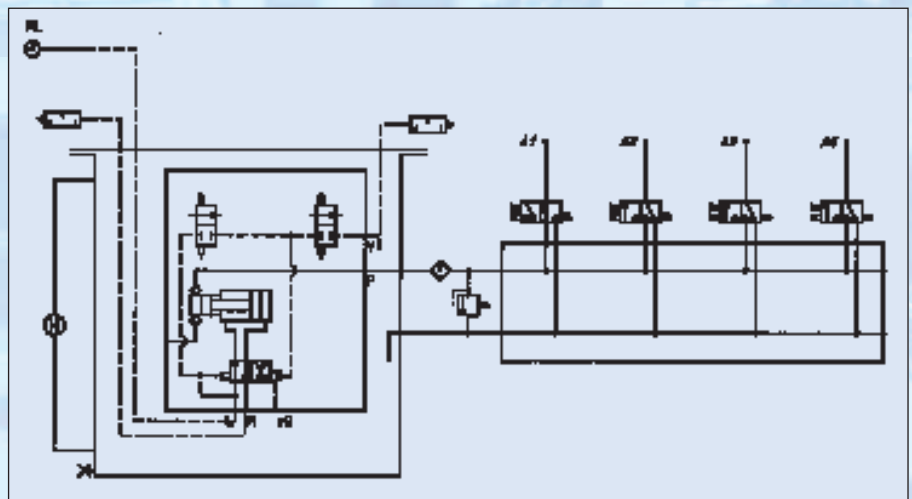

MAXIMATOR® Hydraulic Unit

Type MO 22 D

Configuration

The power pack contains the following components:

- MAXIMATOR pump MO22D
- Aluminium tank of 6.5 liter
- Pressure gauge 0-250 bar, Ø 63 mm
- Accumulator, volume 0.7 liter with safety devices
- Flange block with valves, nominal size 6
- Oil collecting recipient

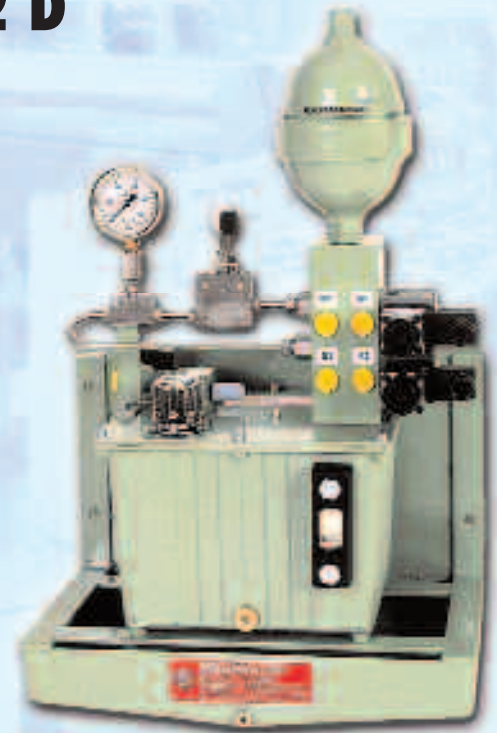

Advantages

- Almost pulsation-free pressure build-up
- Continuous movement of the lid
- Compact design, minimum space requirement
- No energy consumption after having reached the set final pressure
- No heating of the pressure medium

Application

This power pack will be used for moving and locking, by means of a hydraulic cylinder, cover lids of centrifuges. The lid moving has to be realized continuously with constant speed.

The power pack is designed for being fixed to walls. In case of damage, an air collecting trough receives the oil quantity of the tank.

Technical features

Pump model:	MO 22 D
Pressure ratio:	1 : 28
Maximum outlet pressure:	280 bar
Maximum air drive pressure:	9 bar
Maximum flow capacity:	approx. 3.9 l/min
Approx. dimensions of the power pack (LxWxH):	400 x 250 x 650 mm
Approx. weight of the power pack:	25 kg

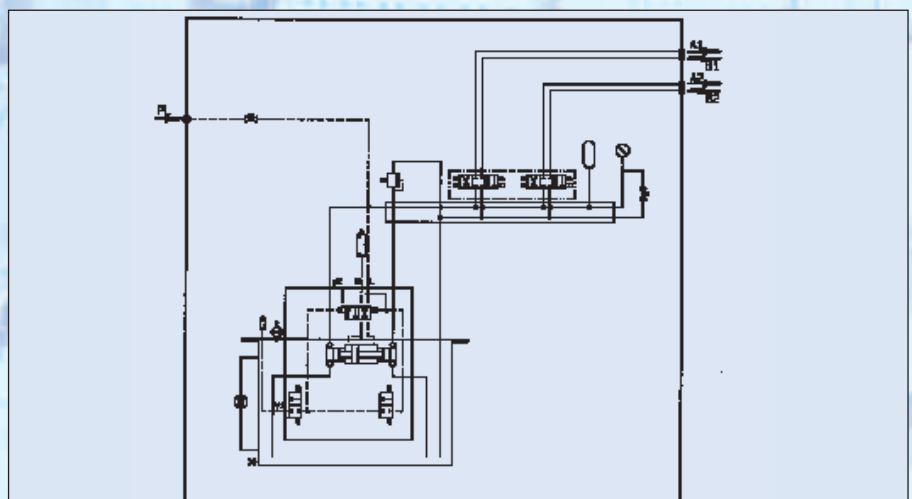

MAXIMATOR® Clamping Unit

Type S 25 D

Configuration

The power pack contains the following components:

- MAXIMATOR pump S 25 D
- Aluminium tank of 6.5 liter with accessories
- Protection hood with integrated operating instruments
- Air control unit
- Pressure gauge 0-250 bar, Ø 63 mm
- Air operated directional valves
- Pressure relief valves
- Quick couplings

Advantages

- Almost pulsation-free pressure build-up
- Compact design, minimum space requirement
- No energy consumption after having reached the set final pressure
- No heating of the pressure medium

Technical features

Pump model:	S 25 D
Pressure ratio:	1 : 25
Maximum outlet pressure:	250 bar
Maximum air drive pressure:	10 bar
Maximum flow capacity:	approx. 12 l/min
Approx. dimensions of the power pack (LxWxH):	310 x 260 x 500 mm
Approx. weight of the power pack:	33 kg

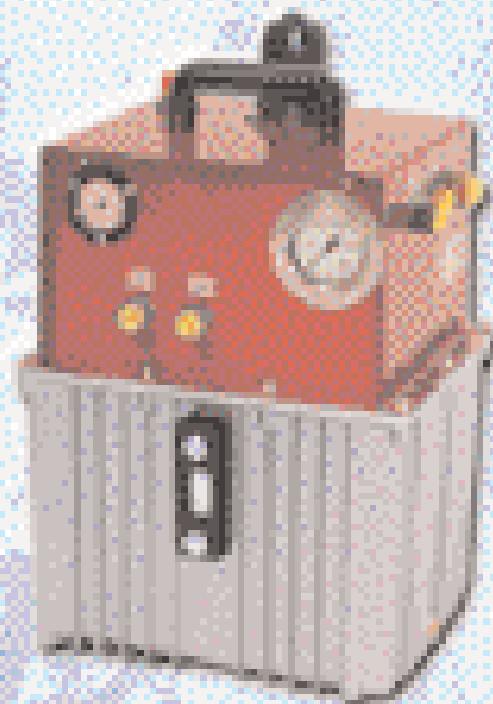

Application

This MAXIMATOR clamping unit as portable and compact hood version will be used in all ranges of the hydraulic clamping and tool system.

In dependence on the required pressure and delivery rate there are available pumps with different pressure ratios and flow rates.

Ranges of application are for example

- hydraulic clamping tools
- actuating of cylinders
- application in riveting tools
- hydraulic presses
- lifting tables, elevating platforms

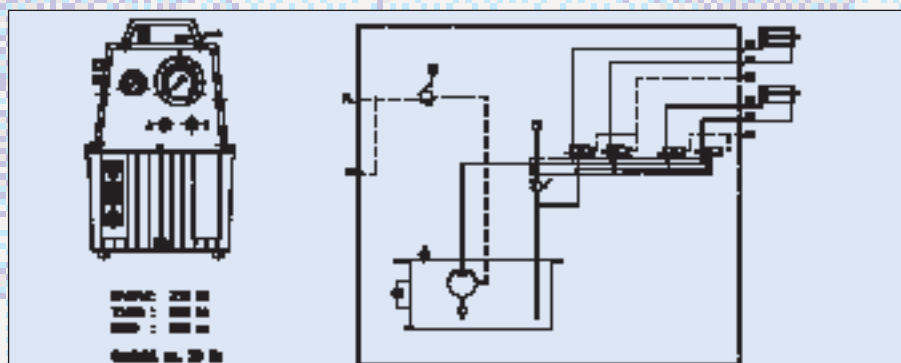

MAXIMATOR® Clamping Units

Pneumatic standard design

1 Clamping circuit – single acting

1* EZ (P)

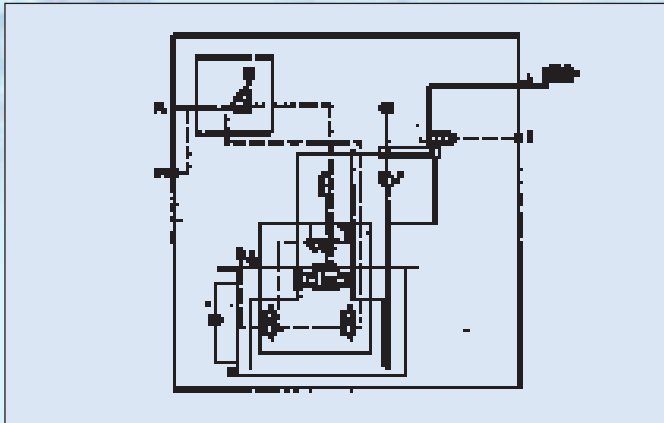

Model key

Order code

S 25 D/FR/13/T/H/O- 250 (63)/1*EZ ((P) /SV VP 54.00.34.05
 S 60 D/FR/13/T/H/O- 600 (63)/1*EZ ((P) /SV VP 54.00.34.07
 S 100 D/FR/13/T/H/O-1000 (63)/1*EZ ((P) /SV VP 54.00.34.08

1 Clamping circuit – double acting

1* DZ (P)

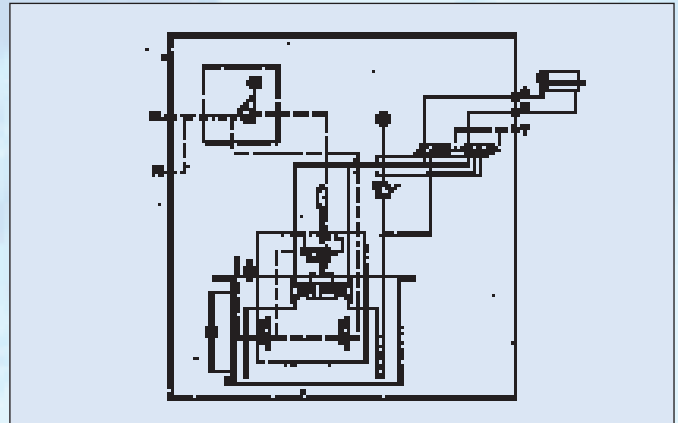

Model key

Order code

S 25 D/FR/13/T/H/O- 250 (63) /1*DZ ((P) /SV VP 54.00.34.01
 S 60 D/FR/13/T/H/O- 600 (63) /1*DZ ((P) /SV VP 54.00.34.03
 S 100 D/FR/13/T/H/O-1000 (63) /1*DZ ((P) /SV VP 54.00.34.04

2 Clamping circuits – single acting

2* EZ (P)

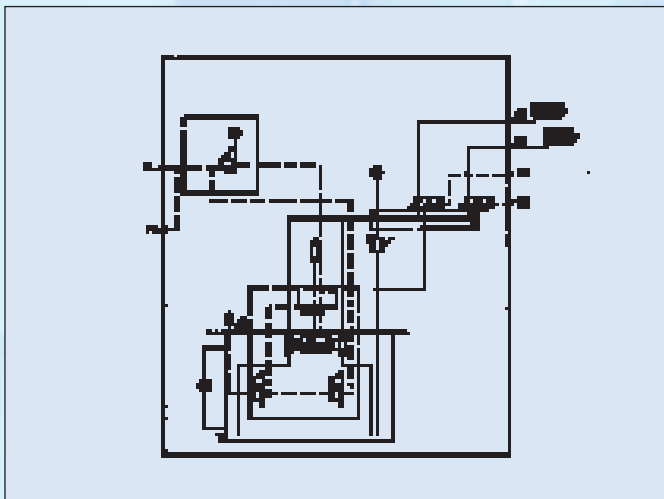

Model key

Order code

25 D/FR/13/T/H/O- 250 (63) /2*EZ ((P) /SV VP 54.00.34.13
 60 D/FR/13/T/H/O- 600 (63) /2*EZ ((P) /SV VP 54.00.34.15
 100 D/FR/13/T/H/O-1000 (63) /2*EZ ((P) /SV VP 54.00.34.16

2 Clamping circuits – double acting

2* DZ (P)

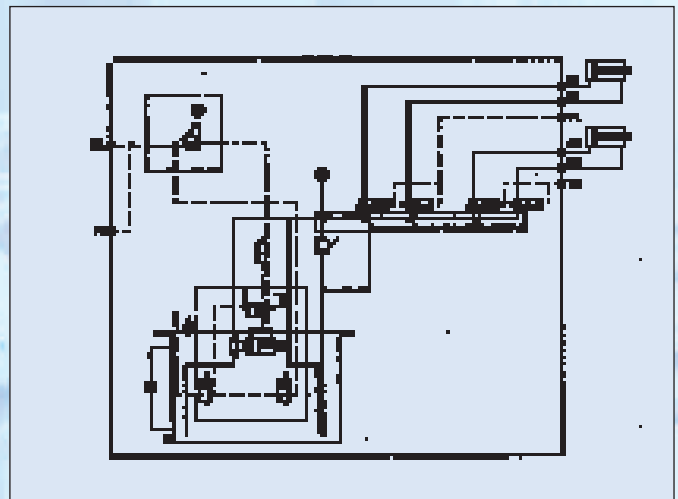

Model key

Order code

S 25 D/FR/13/T/H/O- 250 (63) /2*DZ ((P) /SV VP 54.00.34.09
 S 60 D/FR/13/T/H/O- 600 (63) /2*DZ ((P) /SV VP 54.00.34.11
 S 100 D/FR/13/T/H/O-1000 (63) /2*DZ ((P) /SV VP 54.00.34.12

For ordering an electric drive, please specify voltage, e. g.: VP 54.00.34.01-24 V ; VP 54.00.34.01-220 V

PZ 3-1 (R)  Marked with A; A1; A2 ...
 P 3-1  Marked with B; B1; B2 ...
 Pilot air  Marked with Y; Y1; Y2 ...

Width: 310 mm
 Depth: 260 mm
 Height: 500 mm
 Weight: approx. 33 kg

MAXIMATOR® Clamping Unit**Type S 35****Configuration**

The power pack contains the following components:

- MAXIMATOR pump S35
- Aluminium tank of 6.5 liter with accessories
- Protection hood
- Air control unit
- Pressure gauge 0-400 bar, Ø 63 mm
- Air operated directional valves

**Advantages**

- High pressure, high flow capacity
- Compressed-air drive, easy to maintain
- No energy consumption after having reached the set final pressure
- No heating of the pressure medium

Application

The clamping unit presented here will be used for driving very different tools. Its universal applicability is due to its robust and simple constructional design. In the above example, the mobile pressure generating unit is provided for operating a hydraulically actuated chain cutter for being used in the underground mining.

Further applications:

- hydraulic punch tools
- hydraulic clamping and cutting tools
- actuating of cylinders
- hydraulic presses

Technical features

Pump model:	S 35
Pressure ratio:	1 : 39
Maximum outlet pressure:	390 bar
Maximum air drive pressure:	10 bar
Maximum flow capacity:	approx. 4.3 l/min
Approx. dimensions of the power pack (LxWxH):	310 x 240 x 420 mm
Approx. weight of the power pack:	18 kg

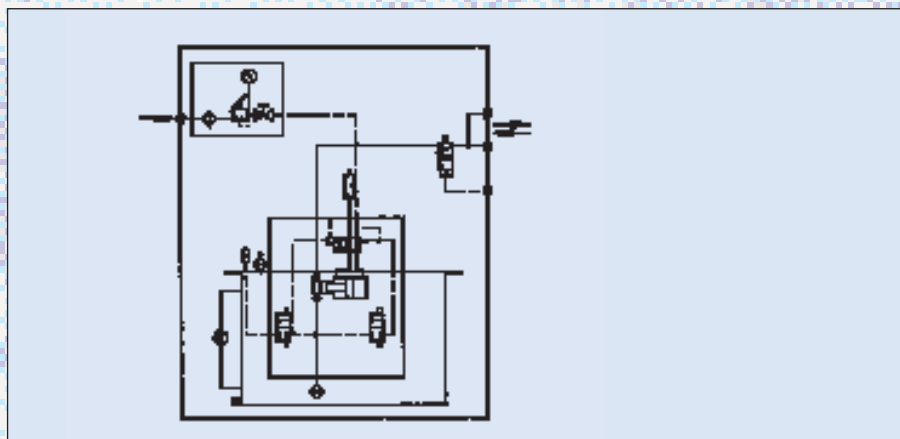

MAXIMATOR® Clamping Unit**Type MO 22 SN****Configuration**

The power pack contains the following components:

- MAXIMATOR pump MO22SN
- Valve block with integrated oil tank
- 3/2 directional valve, nominal size 6
- 1 pce. air pilot switch each to start and stop the unit at a pre-defined pressure
- Pressure gauge 0-250 bar, Ø 63 mm
- Oil sight glass
- Pressure relief valves
- Filling socket and ventilation

Advantages

- No energy consumption after having reached the set final pressure because the pump stops automatically
- Long pressure holding times without energy consumption
- Pump substitutes leakage losses through automatic re-delivery
- Simple mounting, handy construction

Technical features

Pump model:	MO 22 SN
Pressure ratio:	1 : 28
Maximum outlet pressure:	280 bar
Maximum air drive pressure:	10 bar
Maximum flow capacity:	approx. 2.2 l/min
Approx. dimensions of the power pack (LxWxH):	180 x 320 x 80 mm
Approx. weight of the power pack:	6 kg

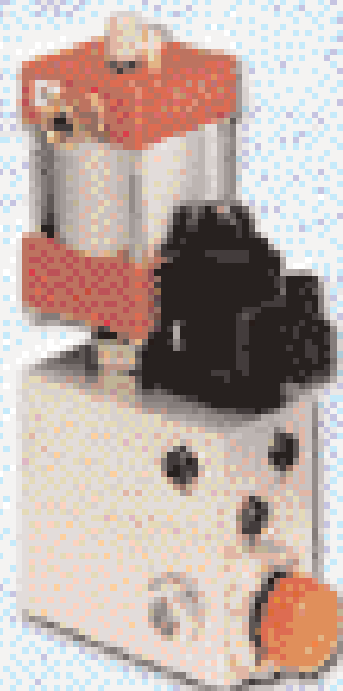
**Application**

This hydropneumatic clamping unit has been designed in particular for being used at NC circular-indexing tables.

In addition to that, this handy and compact hydraulic unit is of universal applicability wherever hydraulic pressures and low flow rates will be used with minimum space requirement.

The mounting position of the power pack is just as you like, the filler and ventilator can be mounted on three sides.

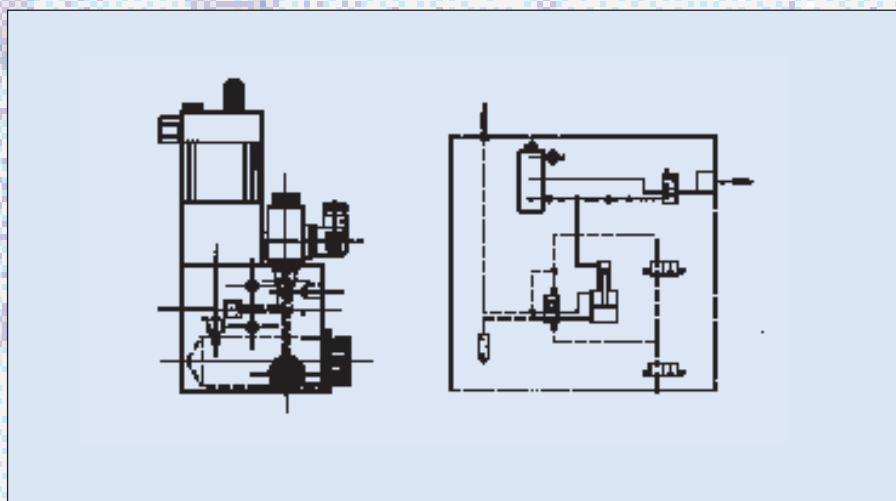

MAXIMATOR® Hydraulic Power Pack

Type M 72-01

Configuration

The power pack contains the following components:

- MAXIMATOR pump M 72-01
- Hand lever
- Air control unit, type "C1"
- Air safety valve
- Tank of stainless steel, volume 13 liter
- Pressure gauge 0-400 bar ø 100
- Relief valve, type EV
- Pressure outlet with shut-off valve, type AV
- Protective frame
- Adapter for connecting hoses

Advantages

- Power pack in rough and damage protected design
- Compact system
- Corrosion resistant due to stainless steel design
- No energy consumption when the set operating pressure is reached once
- Pressure can be built up, even there is no shop air available
- Easy to operate

Technical features

Pump model:	M 72-01
Pressure ratio:	1 : 86
Maximum outlet pressure:	400 bar
Maximum air drive pressure:	4.5 bar
Maximum flow capacity:	approx. 0.7 l/min
Approx. dimensions of the power pack (LxWxH):	420 x 350 x 450 mm
Approx. weight of the power pack:	22 kg

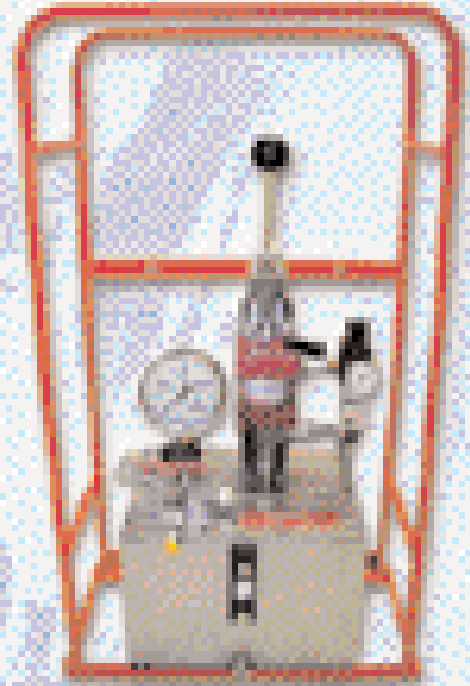

Application

This compact power pack in portable stainless steel frame design is suitable for mobile applications.

The pressure can be built up in short term by using the hand lever even there is no shop air available.

Examples:

- Burst pressure tests
- Internal high pressure forming
- Leakage tests
- Etc.

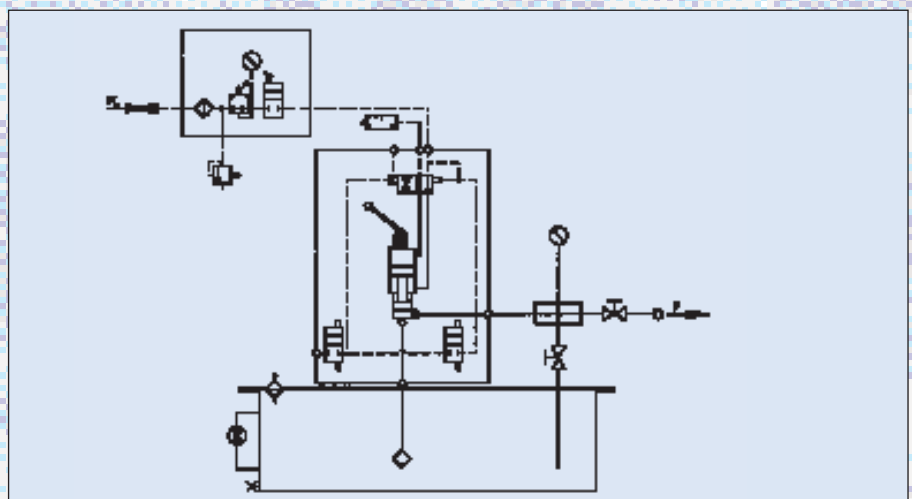

MAXIMATOR® Hydraulic Power Pack

Type G 25-2 LVE

Configuration

The power pack contains the following components:

- MAXIMATOR pump G 25-2 LVE
- Air control unit, type "C2"
- Stainless steel tank, volume 30 liter
- Carrying handles
- Manifold block of stainless steel
- Pressure gauge 0-600 bar ø 100
- Relief valve, type EV
- Pressure outlet with shut-off valve
- Adapters in common sizes

Advantages

- Ready made and complete solution
- Corrosion resistant stainless steel design
- Suitable for series tests
- Can be connected i. e. to the water supply
- Filling and pressure build-up in short time through pump with double air drive head

Technical features

Pump model:	G 25-2 LVE
Pressure ratio:	1 : 56
Maximum outlet pressure:	560 bar
Maximum air drive pressure:	10 bar
Maximum flow capacity:	approx. 6.19 l/min
Approx. dimensions of the power pack (LxWxH):	490 x 340 x 700 mm
Approx. weight of the power pack:	34 kg

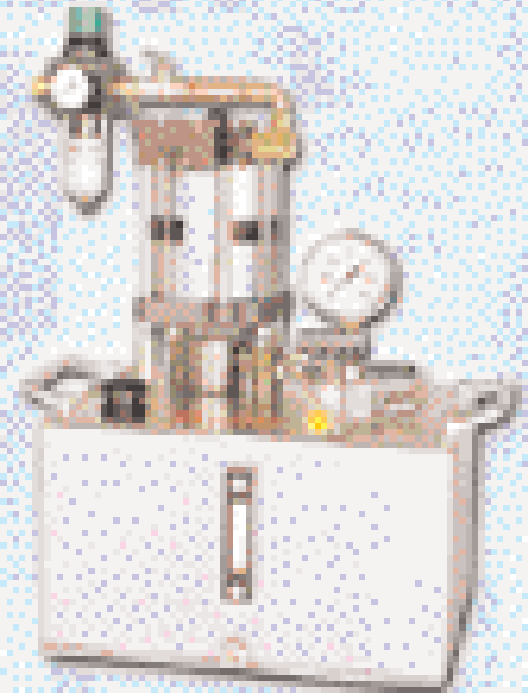

Application

This portable hydraulic power pack can be used in all applications where pressure test shall be realized, i. e. for TÜV approvals.

Examples:

- Receivers for fire extinguishers
- Breathing air cylinder
- Compressed gas accumulators
- Gas cylinders
- Etc.

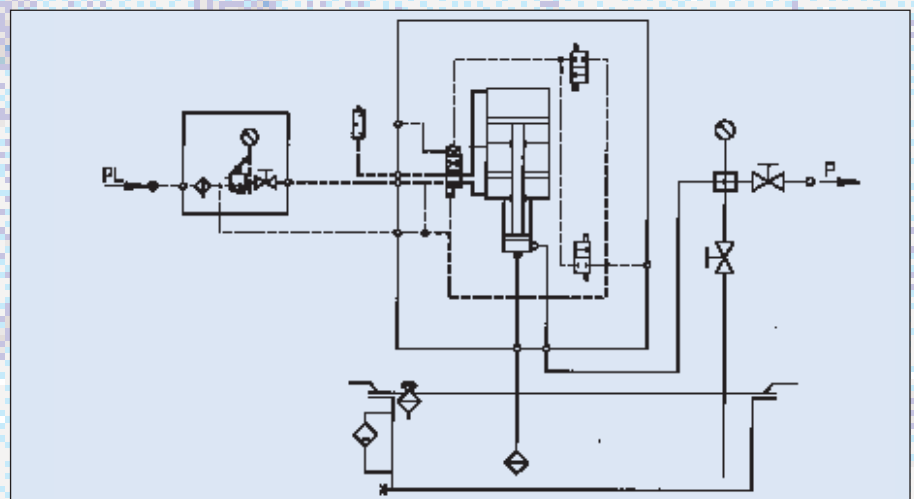

MAXIMATOR® Hydraulic Power Pack

Type G 500-2 L

Configuration

The power pack contains the following components:

- MAXIMATOR pump G 500-2 L
- Air control unit, type "C2"
- Air safety valve
- Stainless steel tank, volume 70 liter
- Mobile design
- Pressure gauge 0-7,000 bar Ø 160
- Relief valve, type EV
- Pressure outlet with shut-off valve
- All wetter materials of stainless steel

Advantages

- Very high test pressures can be achieved
- Wide adjustable pressure range
- Mobile pack
- Safe design

Technical features

Pump model:	G 500-2 L
Pressure ratio:	1 : 1,038
Maximum outlet pressure:	5,500 bar
Maximum air drive pressure:	6.5 bar
Maximum flow capacity:	0.3 l/min
Approx. dimensions of the power pack (LxWxH):	620 x 480 x 820 mm
Approx. weight of the power pack:	48 kg

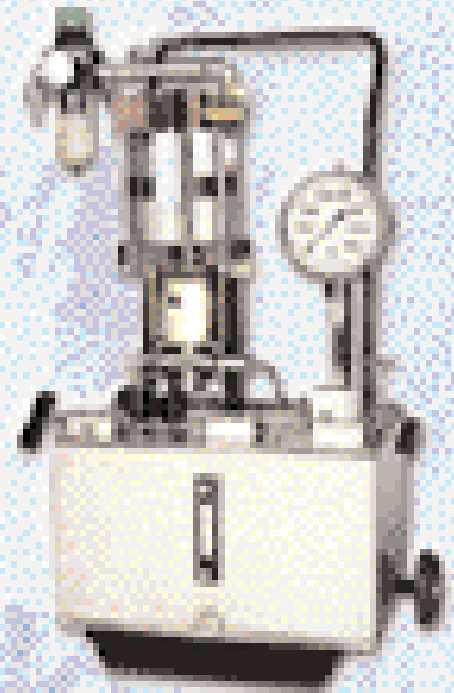

Application

This mobile MAXIMATOR system can be used in all applications where high pressure and low flow rates are required.

Examples:

- Pressure and leak tests on receivers
- Burst pressure tests on hp hoses and systems
- etc.

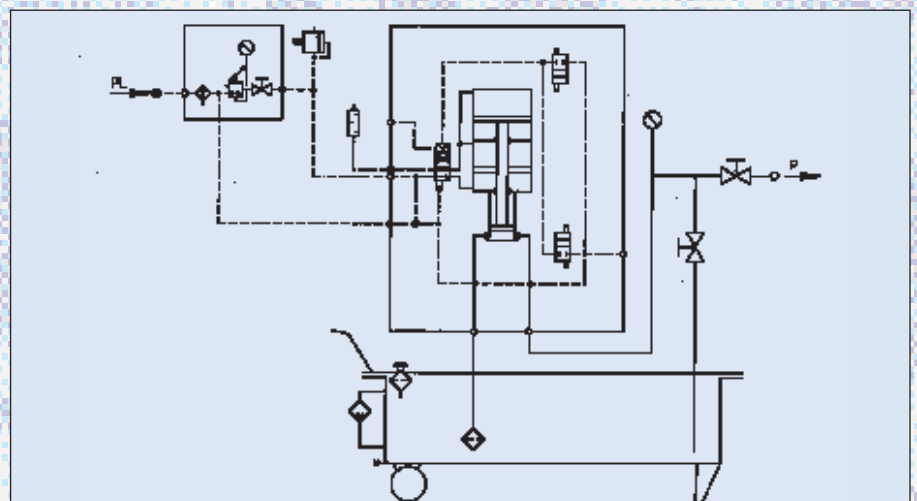

MAXIMATOR® Test Station**Type DPD200 / G400L****Configuration**

The power pack contains the following components:

- MAXIMATOR pump DPD200
- MAXIMATOR pump G 400 L
- Electric pump 5.5 KW
- Air control units, type "C2"
- Shut-off valves and line filters
- Stainless steel frame on wheels
- Pressure transducer with digital display
- Pressure gauge 0-250 bar Ø 100
- Electric directional valves
- Pressure relief valves
- All wetted materials of stainless steel

Advantages

- High flow capacity
- High outlet pressures
- Rough stainless steel design
- Directly connected to the water supply
- Suitable for special liquids

Technical features

Pump models:	as above
Pressure ratio:	1 : 286 / 1:398
Maximum outlet pressure:	2,200 bar
Maximum air drive pressure:	5.5 bar
Maximum flow capacity:	approx. 20 l/min
Approx. dimensions of the power pack (LxWxH):	950 x 1250 x 880 mm
Approx. weight of the power pack:	180 kg

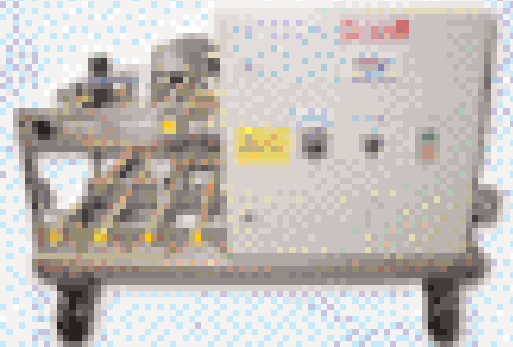
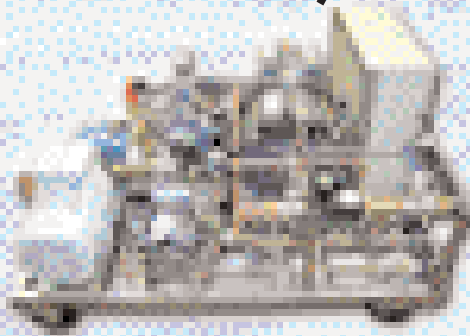
**Application**

This mobile power pack can be used on construction sites for pressure and leak tests on pipelines.

Three pumps with different pressure ratios and pressure ranges are pneumatically or electrically driven.

It is built in user friendly design with control cabinet for pressure observation and regulation.

Example:

- Power pack for injecting corrosion inhibitors into pipelines and systems
- For pressure and leak tests
- Etc.

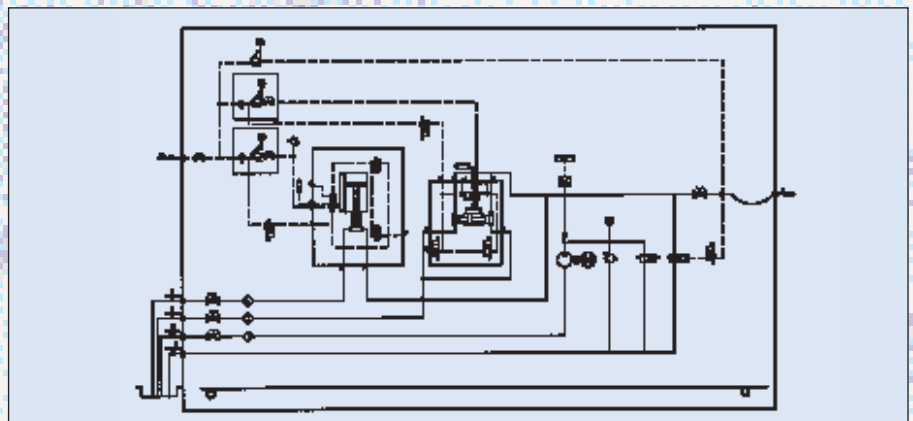

MAXIMATOR® Hydraulic Power Pack

Type G 25 DVE

Configuration

The power pack contains the following components:

- MAXIMATOR pump G 25 DVE
- Air control unit, type "C2"
- Stainless steel tank, volume 70 liter, with accessories
- Workshop chart design
- Pressure gauge 0-250 ø 160
- Accumulator 2.5 Liter / 330 bar
- Pressure relief valve
- Proportional valve
- Digital pressure transducer and display
- Electric box with power supply
- Complete drive hydraulics

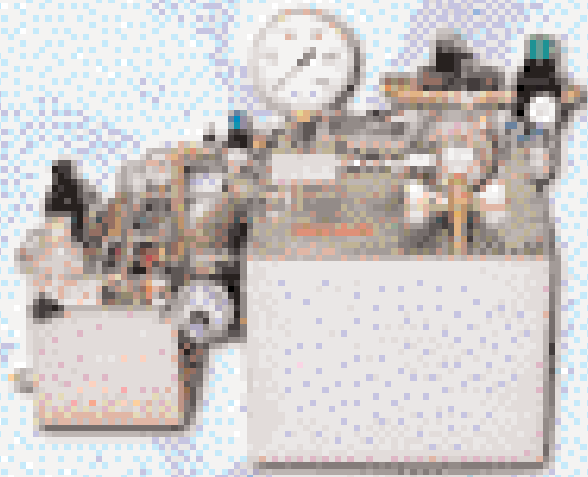

Advantages

- Pulsation-free pressure tests
- Continuous control
- Reproducibility: ± 1 bar
- Modulair design with electronic measuring and regulating technique

Technical features

Pump model:	G 25 DVE
Pressure ratio:	1 : 27
Maximum outlet pressure:	250 bar
Maximum air drive pressure:	9 bar
Maximum flow capacity:	11 l/min
Approx. dimensions of the power pack (LxWxH):	1000 x 700 x 550 mm
Approx. weight of the power pack:	65 kg

Application

This complete solution for applications in water hydraulics permits pulsation-free pressure tests on test specimen with an excellent electronic pressure regulation.

Examples:

- Burst pressure tests
- Leak tests
- Internal high pressure forming
- Long term tests
- Etc.

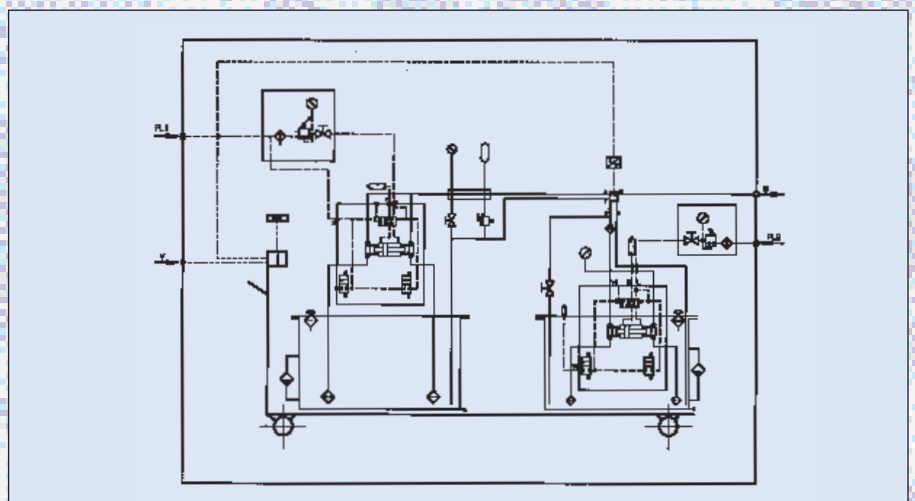

MAXIMATOR® Hydraulic Power Pack

Type M 37 LVE

Configuration

The power pack contains the following components:

- MAXIMATOR pump M 37 LVE
- Air control unit, type "C1"
- Stainless steel tank, volume 13 liter, with accessories
- On wheels
- Pressure gauge 0-400 Ø 100 for accumulator
- Accumulator 2.5 Liter / 330 bar
- Pressure relief valve
- Pressure release valve
- Pressure regulator at the outlet
- Outlet pressure gauge 0-40 bar Ø 63

Advantages

- Accurate regulation of the outlet pressure
- Easy to operate
- All wetted parts of corrosion resistant materials
- Energy saving
- No cooling required

Technical features

Pump model:	M 37 LVE
Pressure ratio:	1 : 46
Maximum outlet pressure:	400 bar
Maximum air drive pressure:	8.5 bar
Maximum flow capacity:	1.3 l/min
Approx. dimensions of the power pack (LxWxH):	420 x 350 x 550 mm
Approx. weight of the power pack:	23 kg

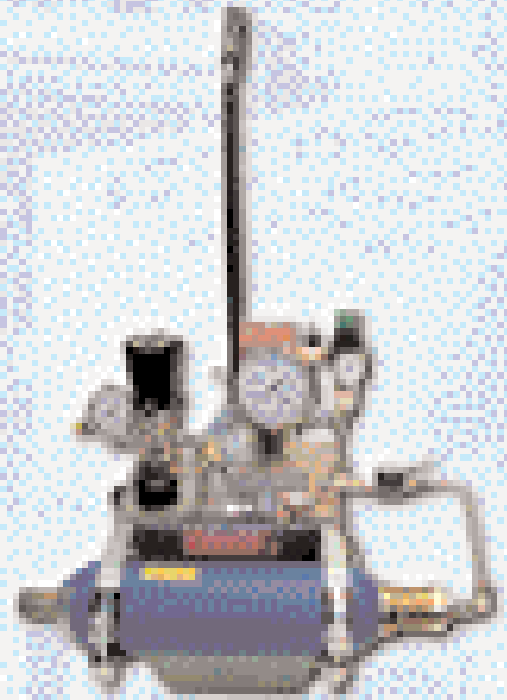

Application

This system can be used in all applications where small pressure tests have to be made.

By combining pressure generation, pressure storage and pressure regulation, it is possible to get stored energy, in this case a water pressure of 40 bar.

Examples:

- Burst pressure tests
- Control of pipelines
- Leak tests
- Internal high pressure forming
- Compression of materials
- Etc.

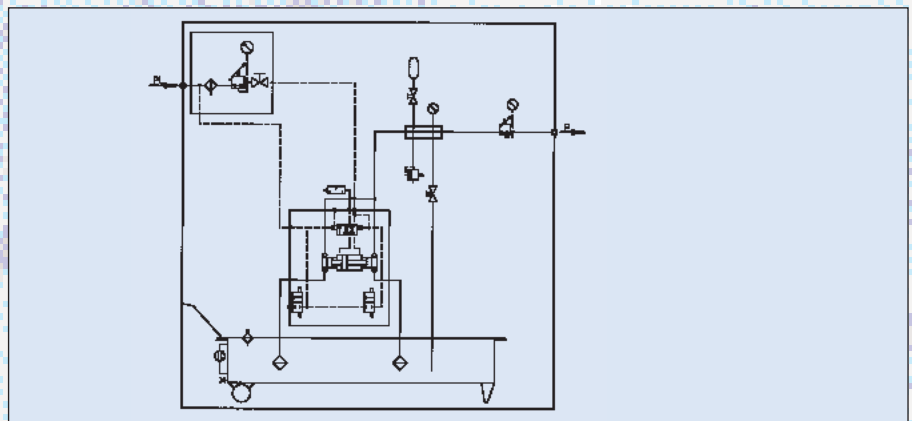

MAXIMATOR® Hydraulic Power Pack

Type M 189 L / M 189-2 L

Configuration

The power pack contains the following components:

- MAXIMATOR pumps, M189L and M189-2L
- Air control units, type "C1"
- Air safety valves
- Aluminium tank, volume 13 liter, with accessories
- On wheels
- Pressure gauges 0-1,600 Ø 100, 0-2,500 Ø 160
- Pressure relief valves, type EV
- Shut-off valves, type AV1
- High pressure hoses, type SK 6005
- Quick couplings

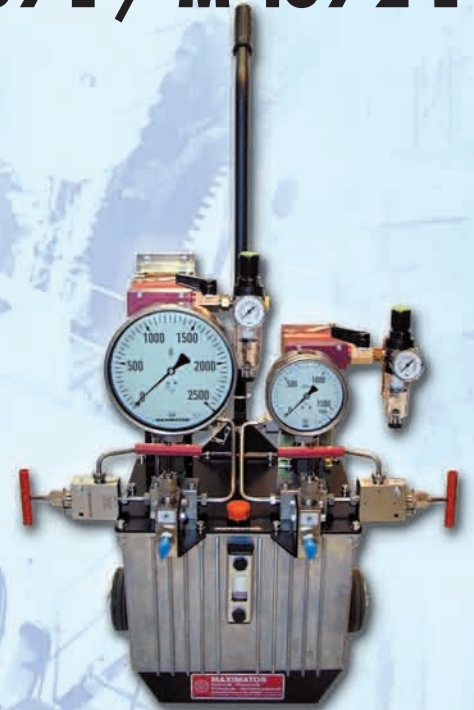

Advantages

- Pressure build-up in two different ranges at the same time
- Automatic pumping in case of leakages
- Easy to operate
- High mobility through compact design
- Suitable for various liquids

Technical features

Pump models:	M189L / M189-2L
Pressure ratio:	1:220 / 1:450
Maximum outlet pressure:	2,500 bar
Maximum air drive pressure:	5.5 bar
Maximum flow capacity:	0.48 l/min
Approx. dimensions of the power pack (LxWxH):	310 x 240 x 450 mm
Approx. weight of the power pack:	17.5 kg

Application

Two MAXIMATOR pumps with different pressure ratios are used for generating the pressure for hydraulic interference fits. So cams and gear parts can be expanded and displaced at the same time. These power packs are especially designed on customers request depending on the application and their specific requirements.

Examples

- Hydraulic interference fits
- Expansion and displacement of hubs
- Actuation of hydraulic stamps
- Lifting equipment
- Torque tensioning of screws
- Etc.

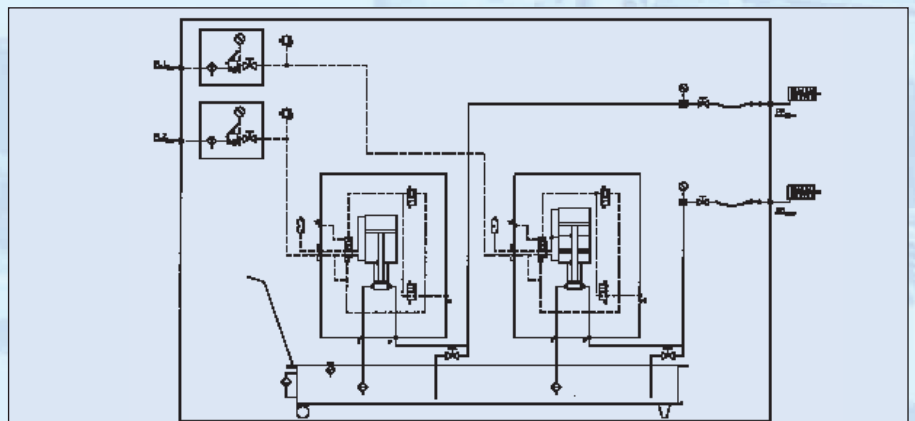

MAXIMATOR® Hydraulic Power Pack

Type G 300 L

Configuration

The power pack contains the following components:

- MAXIMATOR pump G 300 L
- Air control unit, type "C2"
- Air safety valve
- Aluminium tank, volume 13 liter, with accessories
- On wheels
- Outlet pressure gauge 0-4,000 Ø 160
- Pressure relief valve, type EV
- 2 Pressure outlets with shut-off valve each, type AV2
- 2 High pressure hoses, type SK 6005
- Protective frame in special design

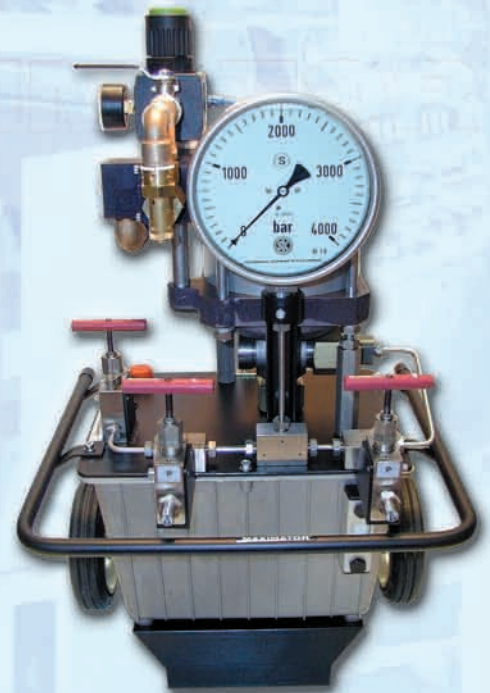

Advantages

- Easy to operate
- Rough design for difficult ambient conditions
- No cooling required
- System-integrated safety devices
- Suitable for different hydraulic liquids as well as for water
- All wetted parts of corrosion resistant materials

Technical features

Pump model:	G 300 L
Pressure ratio:	1 : 314
Maximum outlet pressure:	3,140 bar
Maximum air drive pressure:	10 bar
Maximum flow capacity:	0.7 l/min
Approx. dimensions of the power pack (LxWxH):	340 x 290 x 790 mm
Approx. weight of the power pack:	29 kg

Application

This mobile power pack offers a wide range of applications. It can be used to loose and tighten interference fits as well as to generate the pressure for screw clamping devices.

Examples

- Density tests
- Burst pressure tests
- Leak tests
- Autofrettage
- Long term tests
- Etc.

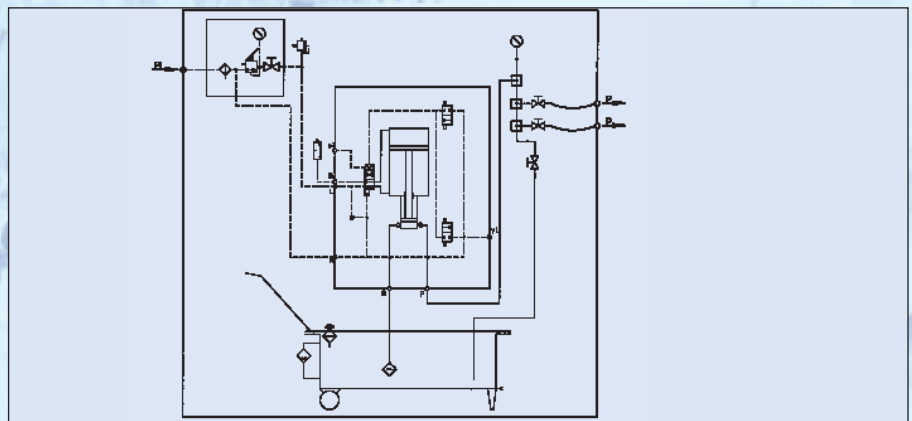

Test Benches

MAXIMATOR has a vast know-how with regard to concept, development, construction and manufacturing of test benches, pressure generating systems and autofrettage systems.

Hoses, pipes, tanks, accumulators, valves, fittings, plastic and ceramic components as well as in particular components of the diesel injection technique (rails, nozzles, nozzle holders, injectors) and other vehicle components (e.g. air bag cartridges, camshafts and intermediate shafts, gears) will be tested and manufactured successfully by means of MAXIMATOR systems.

As complete supplier having many years of experiences with regard to components, power packs and systems, we offer our customers individual solutions being tailored to your special requirements. From the preparation of the performance specification up to the commissioning and training of the personnel you will be accompanied by our experienced engineers and technicians so that your test task will be solved optimally.

A program of benchard systems, a designed modular system of standardized components as well as customized special solutions are available for you and cover the complete range of pressure generation and pressure test.

MAXIMATOR test benches, pressure generating and autofrettage systems reach pressures up to max. 15,000 bar and can be operated with a number of liquids, such as oil, water, HFA, HFC, pentosin, brake fluid or gases (e.g. nitrogen, oxygen, helium).

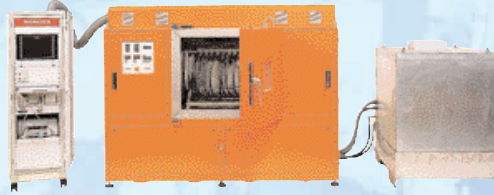

Our test bench line comprises:

- pressure test benches
- bursting pressure test benches
- pulse and durability test benches

- leak test benches
- functional test benches
- high-pressure generating systems
- autofrettage systems



- mandrel extraction machines for hoses
- air bag filling and controlling systems

Furthermore we offer you worldwide an extensive service from the assembly and commissioning over co-worker training up to rotational maintenance of your machine.

As development co-partner of the automobile and components supplying industry we are extremely familiar with the demands on testing, taking down and documenting of the test results and test data administration. On your request, we also take on and document the measuring equipment check test and the calibration of the installed measuring instruments.

In our service center we can realize for you pressure, bursting pressure and pulse pressure tests as well as autofrettage services. Feasibility studies, structural tests, test

and autofrettage of pilot productions or small batches are possible without any problem. This scope of offers will be extended continuously.

Please consult us.



Accessories

MAXIMATOR offers a complete line of high pressure equipment and supplies various accessories for all pneumatic and hydraulic applications. Most items can be shipped ex stock or in short term.

Adapter for pumps and boosters resp. manifold blocks to 1,000 bar with female BSP thread for high pressure hoses with 60° sealing cone and swivel nut

Adapter for pumps and boosters resp. manifold blocks to 1,000 bar with female BSP thread for high pressure tubing

Adapter for high pressure valves and fittings with coned-and-threaded-connectors with female BSP thread up to 4,200 bar

Adapter for high pressure valves and fittings for high pressure hoses with 60° sealing cone and swivel nut up to 4,200 bar

Manually or air operated shut-off valves

Manifold blocks for hydraulic units with relief valve

Manifold blocks for pumps and boosters from 400 bar to 2,500 bar

Manifold blocks for pumps and boosters from 250 bar to 2,500 bar

Manifold blocks with directional valve and pressure relief valve for hydraulic units to 700 bar

Manifold blocks for oil pumps to 700 bar

Fittings (elbows, tees, crosses, couplings, bulkhead couplings)

Gas receivers

Accumulators

Pressure transducers for gas and liquid service from 10 bar to 4,000 bar

Air receiver tanks from 0.75 liter to 350 liter

Pressure regulators for hydraulic units and booster stations for gases

High pressure hoses, nominal size (DN) 5

High pressure hoses, nominal size (DN) 8

Hydraulic tanks, aluminium nominal size 6.5 to 70 liter

Hydraulic tanks, stainless steel, nominal size from 6.5 to 70 liter



Piston shut-off valves for liquids and non-combustible gases from 150 to 1,000 bar

Air control units for pumps and boosters, available in 1/4" BSP to 1/2" BSP

Pressure gauges, Ø 63 mm

Pressure gauges, Ø 100 mm

Pressure gauges, Ø 160 mm

Gauge connections for HP fittings and valves with SF...CX to 1,400 bar and F...C to 4,200 bar

Gauge connections for HP tubing with SF...CX to 1,400 bar and F...C to 4,200 bar

Gauge connections for high pressure fittings and valves with BSP thread to 1,000 bar for higher pressures to 1,400 bar and to 4,200 bar

Pneumatic valves (electrically operated) for pumps, boosters and hydraulic units

Safety valves for compressed air and non-toxic, non-combustible gases from 0.5 to 42 bar, nominal width (DN) 10

Safety valves for vapors, gases and liquids from 0.5 to 250 bar, nominal width (DN) 15

Safety valves for liquids and gases (non-combustible/combustible) from 3.4 to 414 bar

Safety valves for liquids and non-combustible gases from 120 to 1,000 bar

Safety valves for liquids and non-combustible gases from 1,000 to 4,400 bar

Directional seat valves for hydraulic units to 500 bar

MAXIMATOR®

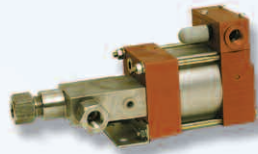

High-pressure pumps for different liquids (oil, water, emulsion etc.)

- easy to maintain, ex-proof
- low energy consumption
- operating pressures up to max. 5,500 bar



Compressed Air Amplifiers

- For increasing air pressure
- Specific air pressure amplification to suit your requirements
- Connection to electrical supply not necessary
- Operating pressure max. 40 bar



High Pressure Compressors

- For pressurizing gases (nitrogen, oxygen, inert gases)
- Simple handling
- Intrinsically safe and explosion proof i. e. not electromotive, but pneumatically powered
- Operating pressure max. 1,000 bar



Gas Assist Injection Systems

- Compressor stations with pneumatic, electric or hydraulic drive
- Control modules with 2, 4 or 8 valves
- Control modules with integrated booster station
- External core pull control systems



High Pressure Valves, Fittings, Tubing

- Stainless steel design
- Temperatures from -250° C to +650° C for liquids and gases
- Maximum outlet pressures up to 10,500 bar

Your Representative:



MAXIMATOR GmbH

Factory

MAXIMATOR GmbH
Walkenrieder Str. 15
D-37449 Zorge / Germany
www.maximator.de

Telephone: ++49 55 86 / 80 30
Facsimile: ++49 55 86 / 8 03 30 40
eMail: info@maximator.de

Internet

All technical and dimensional information subject to change. All general Terms and Conditions of sale, including limitations of our liability, apply to all products and services sold.